

ARCWAVE™

**Ion**

Hit the right nerve

Manual



Go to **arcwave.com** to find the complete manual in your preferred language.

**Arcwave Ion** is the world's first stroker to integrate Pleasure Air™ for the male body. Enjoy as it targets the highly sensitive Pacinian pleasure receptors in the tip of your penis. Hit the right nerve with Arcwave Ion.

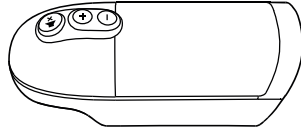
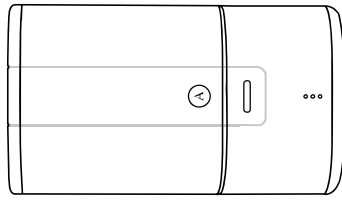

## Index

Get to Know Your Ion .....	6
Start Your Journey .....	10
Cleaning Tips .....	14
Storage & Drying .....	16
Charging Tips .....	19
Troubleshooting Guide .....	21
Warranty & Product Information .....	22

**Get to Know Your Ion**

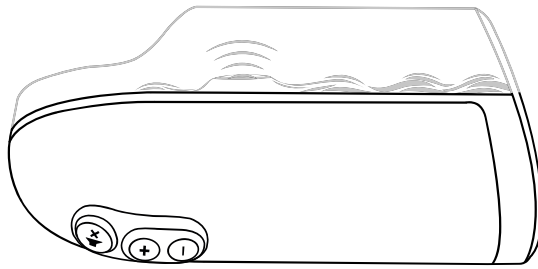

Pleasure Air™



Smart Silence™



Twist to Open



CleanTech Silicone

## Get to Know Your Ion

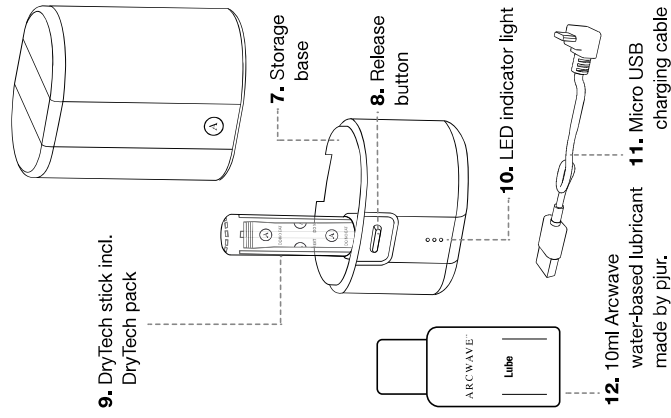
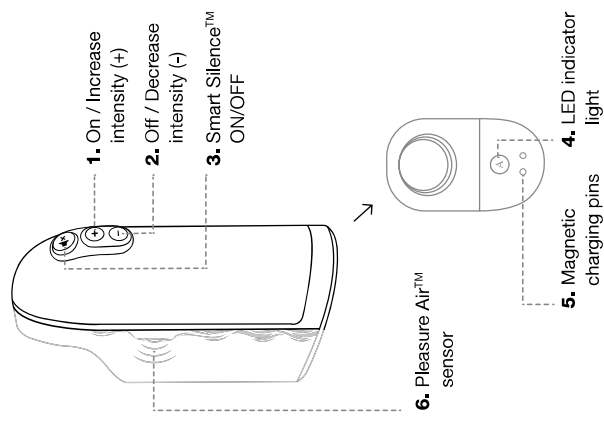

## Start Your Journey

Turn on your device by holding the (+) button for 1 second until the device rumbles.



Ion is now waiting for you in Smart Silence™ mode on the lowest intensity level. You can see when your Ion is on when the logo is glowing.

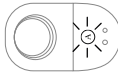

Turn off your device by holding the (-) button for 1 second. You can see when your Ion is off when the Logo is not glowing anymore.

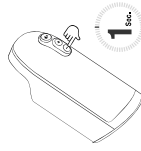

For maximum comfort and to avoid damage, apply a small amount of water-based lube to both your penis and inside your product before every use.



## Smart Silence™

In Smart Silence™ mode, stimulation will not start until the Pleasure Air™ sensor is fully covered. That makes it not only more discreet while in use, but also more pleasurable for you. When the sensor is covered Pleasure Air™ stimulation starts automatically.

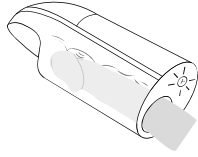

## Smart Silence™ ON/OFF

To deactivate Smart Silence™ mode, hold the Smart Silence™ button (⚡) for 1 second. When Smart Silence™ is deactivated, stimulation remains constantly active – not just when the Pleasure Air™ sensor is fully covered. You can see when the Smart Silence™ button is on when the Smart Silence™ button (⚡) is glowing.





### Pleasure Air™

Insert the penis correctly and place the frenulum (see diagram), on the Pleasure Air™ sensor. The frenulum is the sensitive area of the penis where the head (glans) and the shaft meet on the bottom side.

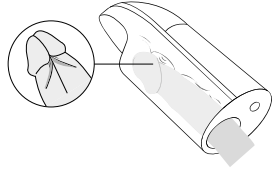

#### Tip

Try placing your thumb on the pressure pads to increase the pressure. More pressure means more stimulation, so play around with what works for you.

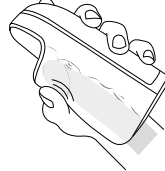

Our CleanTech silicone is engineered for perfect softness and hygienic cleaning. To avoid damage, do not overstretch the silicone with your hands, simply insert the penis.

### Increasing Intensity

You can cycle through 8 increasing intensity levels by pressing (+).



### Decreasing Intensity

You can decrease intensity by pressing the (-) button.



### Standby Mode

Standby mode is designed to make your Ion both battery-friendly and convenient to use. While in Smart Silence™ mode, the device automatically switches off after 3 minutes of inactivity. All LEDs will turn off.

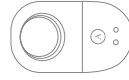
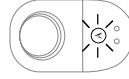

## Cleaning Tips

The Ion is IPX7 waterproof. This means it can be submerged in water without damage.

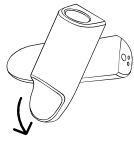

Twist to detach the sleeve from the device.



Immerse the silicone sleeve in water.



Clean the silicone sleeve with toy cleaner or antibacterial soap.

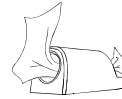

Dry the sleeve with a towel or cloth.

Immerse the device in water and gently wash the Pleasure Air™ opening with your fingers.

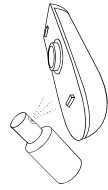

Clean the device with toy cleaner or antibacterial soap.



Dry the device part with a towel.

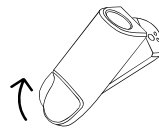

Close twist lock.



## Storage & Drying

Open your storage base by pressing the release buttons.

Place the DryTech pack inside the DryTech stick. This DryTech stick helps to ensure the toy is fully dry.

**Note:** Drying the device before storage can increase the lifespan of the DryTech pack.

The next section describes how to maintain your DryTech pack.

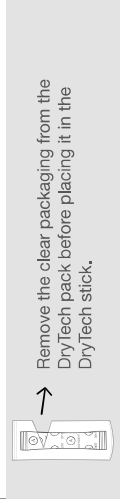
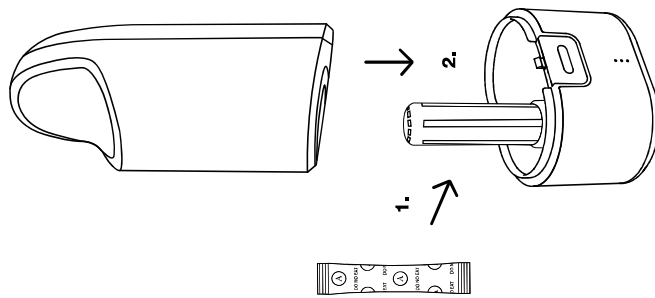
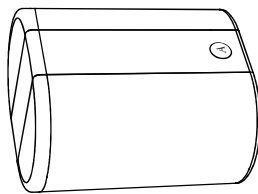

Remove the clear packaging from the DryTech pack before placing it in the DryTech stick.

## Recovery

To recover some of the capacity of your drying pack, remove the DryTech pack from the DryTech stick.

Place the DryTech pack in the microwave on a low power setting of 300W (or use the defrost setting) for 10 minutes. Direct contact with water must be avoided!

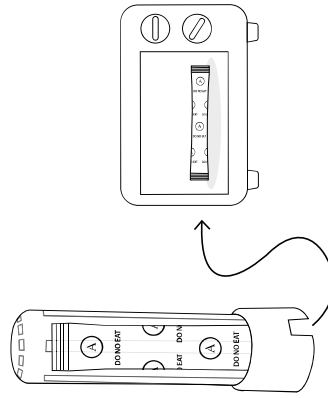

18

## Charging Tips

The Ion's rechargeable battery is shipped pre-charged and may have fully discharged due to environmental factors.

We recommend that you fully charge your Ion before first use. The charging process takes about 85 mins and you can enjoy 60 mins of pleasure at maximum intensity.

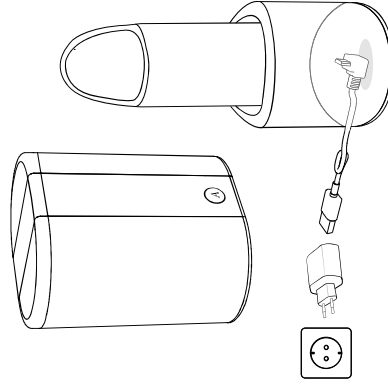

19

## Charging

Connect the USB cable to USB port or adapter. Place your Ion on the DryTech stick with the logo facing downwards. The LEDs on the charging base will light up. Place the lid back on - you're ready to go.

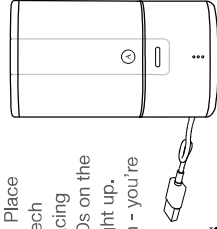

## Battery level status

If the A logo on your Ion is blinking, this indicates the battery is almost empty and the device will turn off within the next 3 minutes. It indicates that it's time to charge your device.

## Charging status on your charging base

The 3 LEDs on the charging base display the current battery level of your device as it is charging as follows:

- Low: the lower LED will blink
- Medium: the middle LED will blink
- High: the top LED will blink
- Fully charged: All LEDs will illuminate

## Troubleshooting Guide

### Issue: Smart Silence™ is not working

**Solution 1:** Clean the Pleasure Air™ sensor. Too much lube in the Pleasure Air™ opening may be covering the Smart Silence™ sensor, preventing it from working properly. Turn your device off, clean the sensor and turn it back on to recalibrate.

**Solution 2:** Recalibrate your device. If the sleeve is detached while the device is turned on, Smart Silence™ may run constantly. Turn off the device, reattach the sleeve and turn it back on to recalibrate.

### Issue: Device doesn't turn ON

**Solution 1:** Check if your device is currently in Smart Silence™ mode. Cover the Pleasure Air™ sensor completely with your finger to check if Smart Silence™ is turned on. You can turn off Smart Silence™ by pressing the Smart Silence™ button for 1 second.

**Solution 2:** The device cannot be turned on while charging.

**Solution 3:** Charge your device. When you first receive your Ion, the device may be fully discharged due to environmental factors.

**Solution 4:** Do not turn on your device, when the Pleasure Air™ Sensor is covered. Make sure the sensor is not covered with lube and that you insert your penis after the device is turned on or you switching back to Smart Silence™.

If you need help contact us at: [care@arcwave.com](mailto:care@arcwave.com)

## Warranty & General Information

WOW Tech™ Europe GmbH offers customers a voluntary manufacturer's warranty for this product in addition to the statutory warranty to which consumers are entitled with respect to sellers. The conditions with respect to the voluntary manufacturer's warranty are on our website, under "Warranty Conditions".

### Content of delivery

- Arcwave Ion
- Storage/charging base
- DryTech stick
- DryTech pack
- USB power cable
- Manual
- 10ml Arcwave water-based personal lubricant made by pjur.
- AC/DC adaptor not included.

## Technical Specifications

Model: ION11A  
AC/DC adaptor rating: Input: 100-240V ~ 50/60 Hz  
Output: 5 V --- 0.75 A

## Environmental Protection

As a distributor of electronic devices, we are legally obliged to accept the return of waste electrical and electronic devices free of charge. We expressly state that you as the user are legally obliged to return used batteries.

Never throw away electronic devices or batteries in the household waste. The symbol shown below, which is also attached to our electronic items, is intended to expressly remind you of this.



## Manufacturer

WOW Tech™ Europe GmbH, Friedenstrasse 91 / 91 a,  
10249 Berlin, Germany

WOW Tech™ Europe GmbH reserves the right to make technical changes and changes to the design that serve to improve the device.

Distributed in North America by  
WOW Tech™ Canada Ltd., 330-1130 Morrison Drive,  
Ottawa, Ontario, Canada K2H 9N6

[www.wowtech.com](http://www.wowtech.com)

Date of issue: 2020, Version 1.1. Designed in Germany.  
Made in China in 2020.



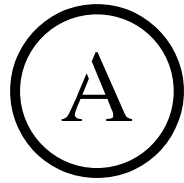

[arcwave.official](#)



[arcwave.com](#)